

Roller Express Smart Motor Operated Shade Installation Instructions

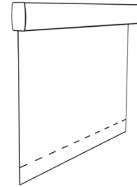
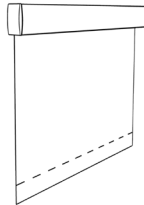
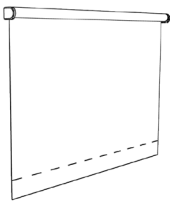
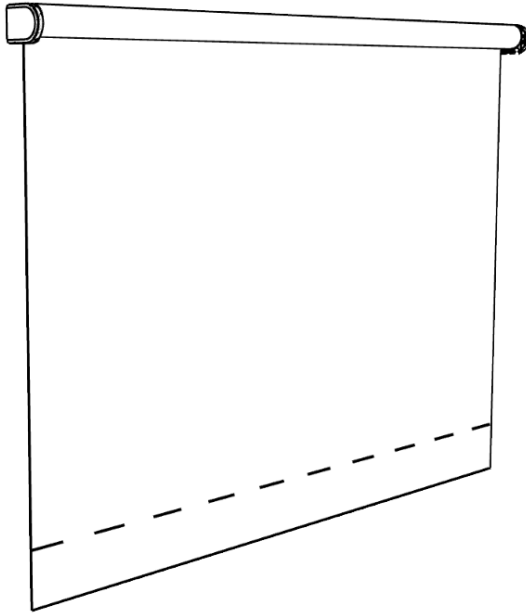

1. Motorized Operated Open Roll
2. Motorized Operated with Deco Fascia
3. Motorized Operated with Contoured Valance

GETTING STARTED

Make sure you have all of the parts and tools required to install your shades.

Tools:

- Measuring Tape
- Power Drill
- #2 Phillips Screwdriver or
- ¼" Hex Head

General Parts to Install Your Shade:



Installation Brackets

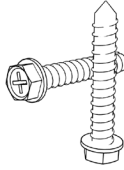

Screws

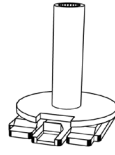

Idler

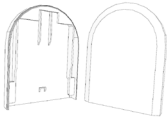

Bracket Cover
(Outside mounted only)

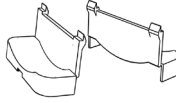

Screw Covers
(Outside mounted only)

Deco Fascia Installation Parts (supplied if Deco Fascia was ordered):



Deco Fascia

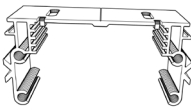

Deco Fascia
Installation Brackets

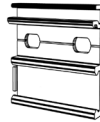

Outside Mount
Backplate
(if ordered)

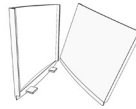

Plastic/Metal
Returns
(if ordered)

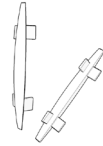

Corner Pieces
(Outside mounted only)

Contoured Valance Installation Parts (supplied only if Contoured Valance was ordered):



Contoured
Valance

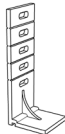

Installation Brackets



Outside Mount
Brackets *(if ordered)*



Corner Connectors
(if ordered)

SECTION 1

MOTORIZED OPERATED SHADE - OPEN ROLL

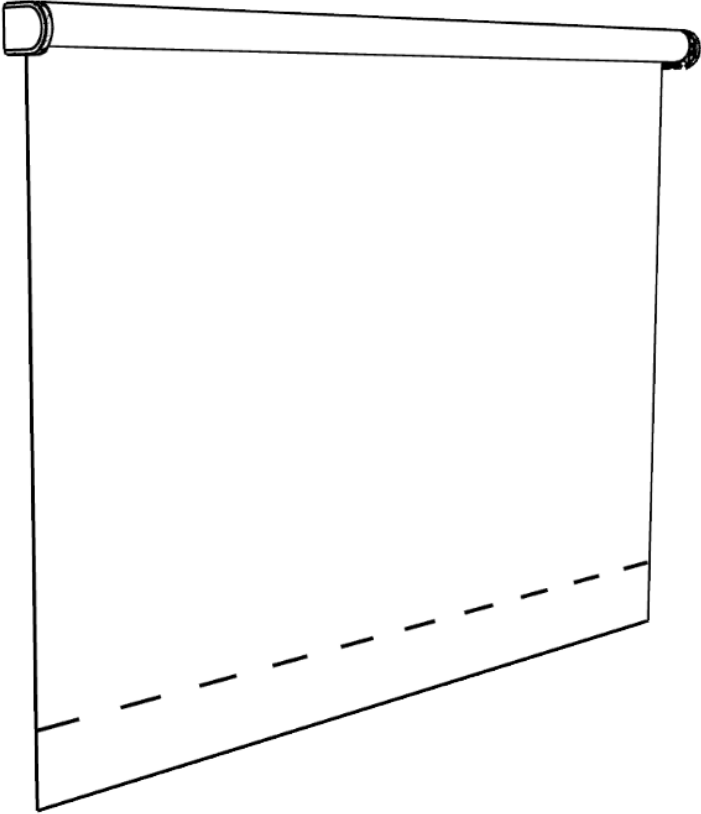

If your shades were ordered with Deco Fascia, proceed to Section 2
If your shades were ordered with Contoured Valance, proceed to Section 3

STEP 1
INSTALLATION BRACKET
PLACEMENT

Using the Drill, secure the roller shade installation brackets with the supplied screws (as shown).

Be sure to check that they are level.

If shade was ordered as Outside Mount, attach the supplied screw covers on to the bracket for a finished look.

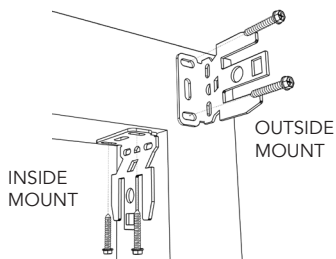

STEP 2
SHADE PLACEMENT

Once the brackets are secured and level, locate the Idler from the parts sent with your shade. Insert the Idler on to the left side bracket (as shown). You should hear a click once it is securely installed.

Grab the roller shade and insert the left side of the shade into the idler (as shown)

Insert the opposite end of the shade onto the bracket as shown.

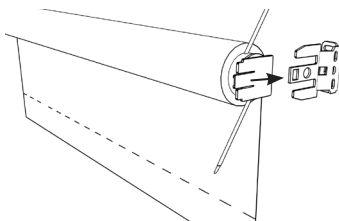
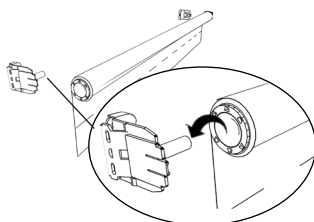
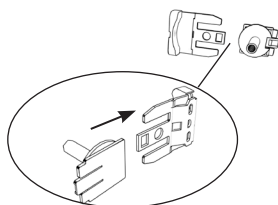
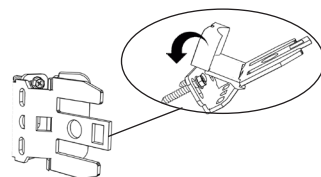

STEP 3
ADDITIONAL ITEMS

If your shade was ordered as Outside Mount, locate the bracket covers and install them onto the installation brackets as shown.

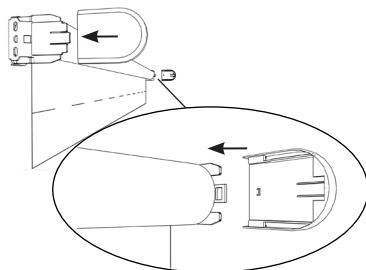

SECTION 2

SMART MOTOR SHADE - WITH DECO FASCIA

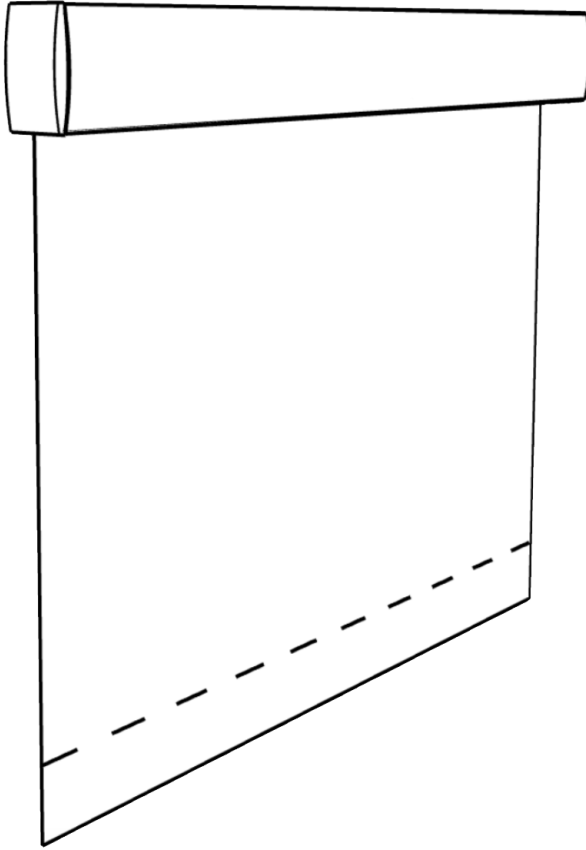

If your shades were ordered with Contoured Valance, proceed to Section 3
If your shades were ordered Open Roll, refer back to Section 1

STEP 1

DECO FASCIA BRACKET INSTALLATION

Using the Drill, secure the Fascia installation brackets with the supplied screws (as shown).

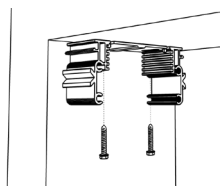

Inside Mount
(Vertical installation - Typical installation)

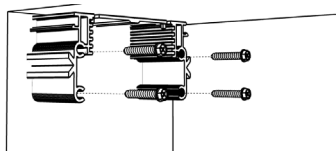

Inside Mount
(Horizontal installation - Possible with longer installation screws)

Outside Mount *(Backplate Placement)*

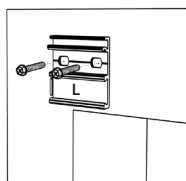

Using the drill secure the backplates to the opening - Each is marked Left or Right. Be sure to check that they are level.

Outside Mount *(Fascia Bracket Placement)*

Slide the Fascia bracket onto the outside mount bracket. Slide all the way to the edge of the bracket until it stops.

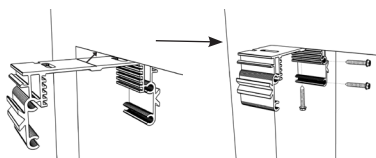

Inside Mount Shade- Outside Mount Bracket *(Fascia Bracket Placement and installation)*

Position the top line against the front edge of the wall then secure the bracket with installation screws as shown.

STEP 2

SHADE BRACKET INSTALLATION

Once the Fascia installation brackets are secured, insert the shade installation brackets into the slots of the Deco Fascia bracket as shown.

For outside mounted shades, the shade bracket should be inserted into the top slot. **Please note: The bracket should be inserted all the way into the slot in order for it to be positioned to stay in place.*

For inside mounted shades, the shade bracket can be moved up or down to perfectly level the shade as needed.

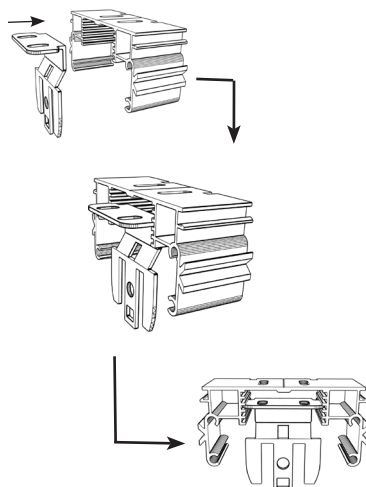

STEP 3

SHADE PLACEMENT

Once the brackets are secured and level, locate the Idler from the parts sent with your shade. Insert the Idler on to the left side bracket (as shown). You should hear a click once it is securely installed.

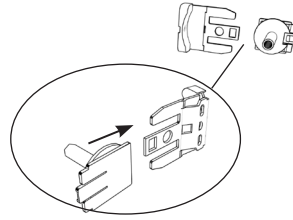

Grab the roller shade and insert the left side of the shade into the idler (as shown)

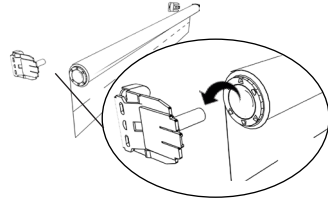

Insert the opposite end of the shade onto the bracket as shown.

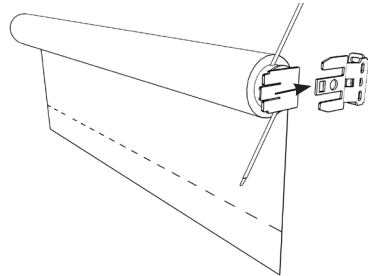

STEP 4

**DECO FASCIA
INSTALLATION**

INSIDE MOUNT

Inside Mounted fascia can be installed by snapping the back groove onto the front notch of each installed Fascia bracket.

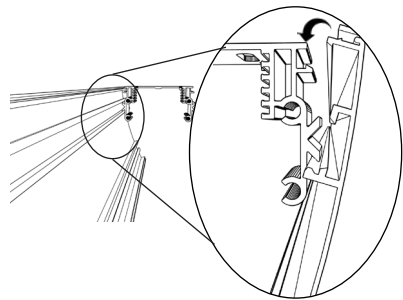

You will hear a click when it is installed

Proceed to next page for
Outside Mount installation

STEP 4 (continued)

DECO FASCIA INSTALLATION

OUTSIDE MOUNT *(if ordered)*

Attach the return with the supplied connector.

- Metal returns will include a plastic corner connector *(outside mount only)*
- Plastic returns simply snap on the end of the fascia *(inside mount shade with outside mounted fascia)*

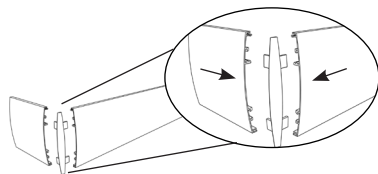

Metal return installation

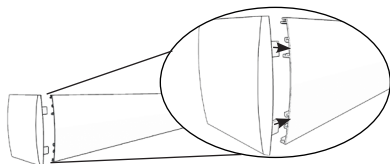

Plastic return installation

Install the fascia by snapping the back groove onto the front notch of each installed Fascia bracket.

You will hear a click when it is installed

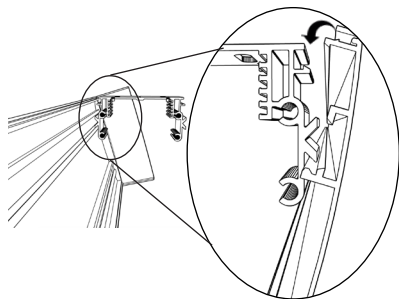

Fascia installation

SECTION 3

SMART MOTOR SHADE
WITH CONTOURED VALANCE

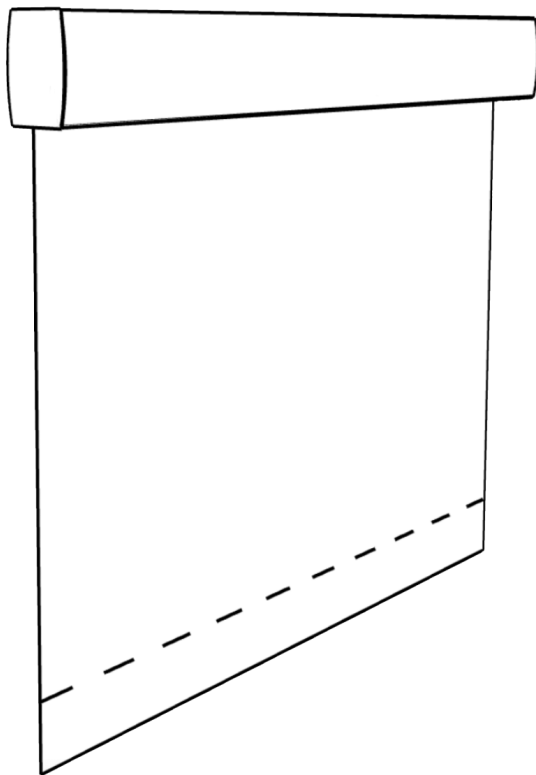

If your shades were ordered with Deco Fascia, refer back to Section 2
If your shades were ordered Open Roll, refer back to Section 1

STEP 1

INSTALLATION BRACKET PLACEMENT

Using the Drill, secure the roller shade installation brackets with the supplied screws (as shown).

Be sure to check that they are level.

If shade was ordered as Outside Mount, attach the supplied screw covers on to the bracket for a finished look.

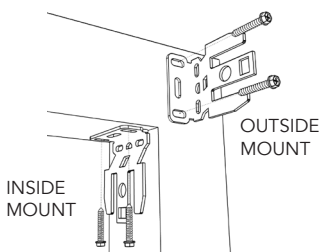

STEP 2

CONTOURED VALANCE INSTALLATION

Prior to installing the Installation Brackets to the wall, insert the Valance onto each Installation Bracket (as shown).

INSIDE MOUNT

Using the Drill, secure the installation Brackets with the supplied screws (as shown).

For a flush inside mounted valance, be sure to leave enough space for the thickness of the valance.

If the window depth does not accommodate a flush mount Installation Bracket, simply snap the bracket at the score as needed.

OUTSIDE MOUNT *(if ordered)*

Install the Outside Mount Bracket to the wall, spacing them evenly. Grab the valance with installed brackets and insert (as shown).

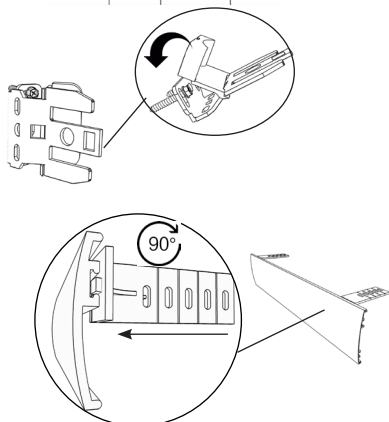

Turn the Valance Installation Bracket and insert at the top of the valance (as shown). Push in lightly to turn the Installation Bracket on a 90° angle until is secured (facing up as shown).

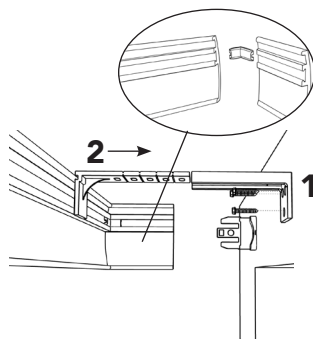
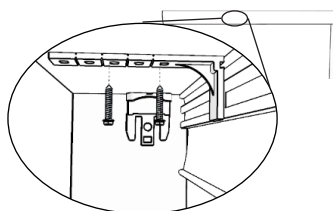

STEP 3

SHADE PLACEMENT

Once the brackets are secured and level, locate the Idler from the parts sent with your shade. Insert the Idler on to the left side bracket (as shown). You should hear a click once it is securely installed.

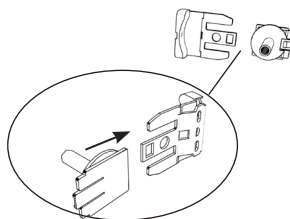

Grab the roller shade and insert the left side of the shade into the idler (as shown)

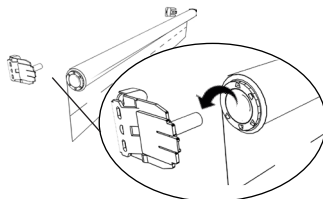

Insert the opposite end of the shade onto the bracket as shown.

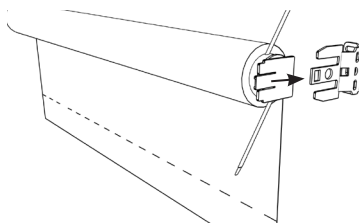

TROUBLESHOOTING

Shade is rolling up on tube unevenly or tracks:

If you notice the material winds unevenly and begins to track or telescope to one side check to ensure that the shade is level. If the shade is not level, remove it from the mounting brackets and shim or reinstall the brackets, as necessary.

IMPORTANT NOTE: Operating a shade that is not level will result in damage to the material. Damage caused by operating an unlevelled shade is not covered under our normal warranty.

PROGRAMING INSTRUCTIONS

Refer to programing instructions included with your order. Online guides can be located using the QR codes below.

HOW TO GUIDES



Remote Control Guide



Otto Recharge Motor Guide



Otto 30/DC2 Motor Guide



App Set Up Guide



Wifi Bridge Set Up Guide



Recharge Battery Pack

VIDEOS



Pairing and Waking the Motor



Setting & Adjusting Limits

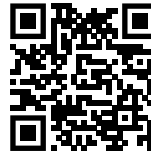

Setting the Favorite Position



Locking & Unlocking the Remote



Group Shades with P1 Button on Motor



Group Shades with P2 Button on Remote