

# Atelier Roller Shade Motorized Operated Shade Installation Instructions

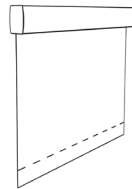
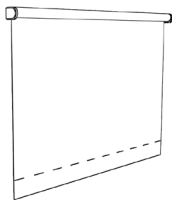
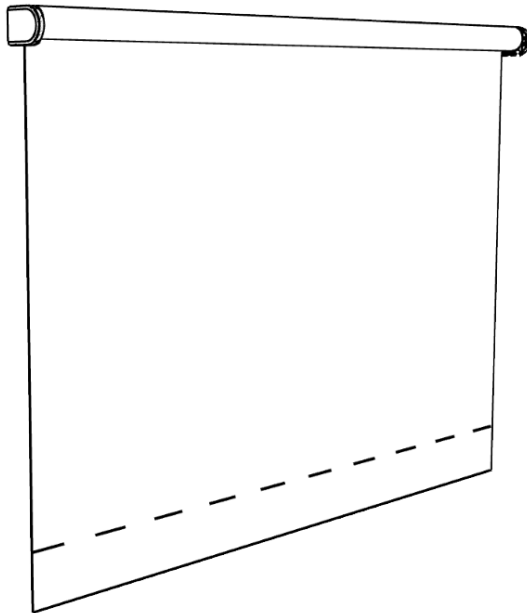

1. Motorized Operated Open Roll
2. Motorized Operated with Deco Fascia

---

# GETTING STARTED

Make sure you have all of the parts and tools required to install your shades.

### Tools:

- Measuring Tape
- Power Drill
- #2 Phillips Screwdriver or
- ¼" Hex Head

### General Parts to Install Your Shade:



Installation Brackets

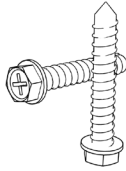

Screws

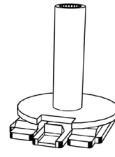

Bearing Pin

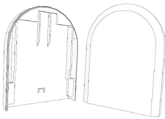

Bracket Cover  
*(if ordered)*

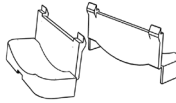

Screw Covers  
*(if ordered)*

### Deco Fascia Installation Parts (supplied if Deco Fascia was ordered):



Deco Fascia

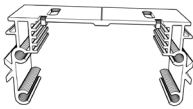

Deco Fascia  
Installation Brackets

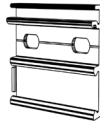

Outside Mount  
Backplate  
*(if ordered)*

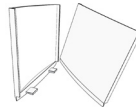

Plastic/Metal  
Returns  
*(if ordered)*

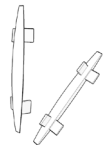

Corner Pieces  
*(Outside mounted  
only)*

---

SECTION 1

MOTORIZED OPERATED SHADE - OPEN ROLL

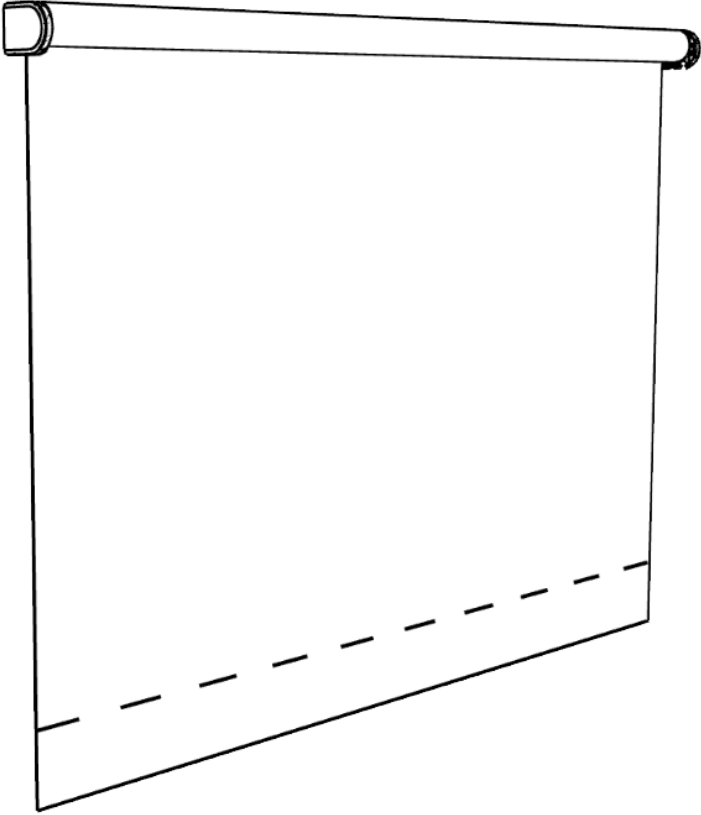

If your shades were ordered with Deco Fascia, proceed to Section 2

---

## STEP 1 INSTALLATION BRACKET PLACEMENT

Using the Drill, secure the roller shade installation brackets with the supplied screws (as shown).

Be sure to check that they are level.

If shade was ordered as Outside Mount, attach the supplied screw covers on to the bracket for a finished look.

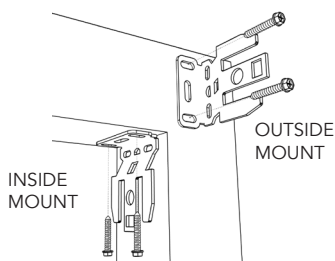

## STEP 2 SHADE PLACEMENT

Once the brackets are secured and level, locate the Bearing Pin from the parts sent with your shade. Insert the Bearing Pin on to the left side bracket (as shown). You should hear a click once it is securely installed.

Grab the roller shade and insert the left side of the shade into the Bearing Pin (as shown)

Insert the opposite end of the shade onto the bracket as shown.

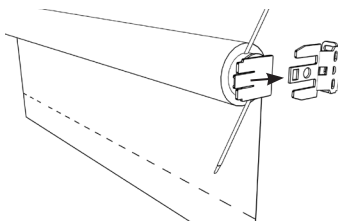
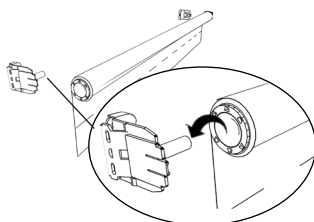
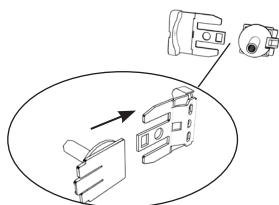
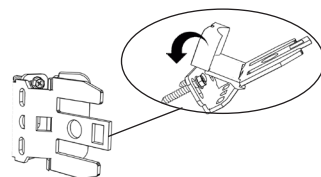

## STEP 3 ADDITIONAL ITEMS

If your shade was ordered as Outside Mount, locate the bracket covers and install them onto the installation brackets as shown. *For programming QR codes, please proceed to the last page.*

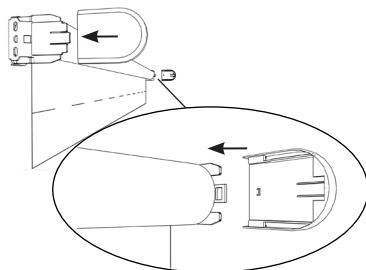

---

SECTION 2

MOTORIZED OPERATED SHADE - WITH DECO FASCIA

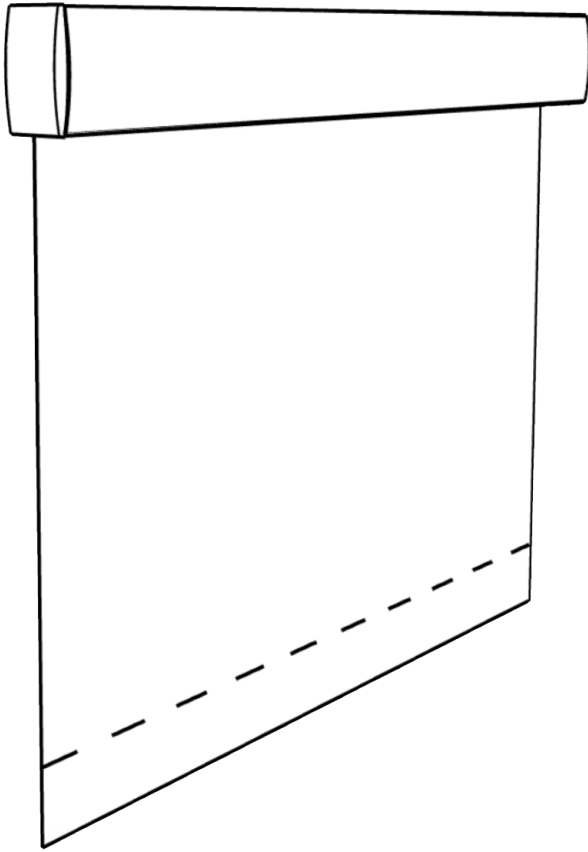

If your shades were ordered Open Roll, refer back to Section 1

STEP 1

# DECO FASCIA BRACKET INSTALLATION

Using the Drill, secure the Fascia installation brackets with the supplied screws (as shown).

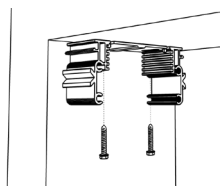

Inside Mount

*(Vertical installation - Typical installation)*

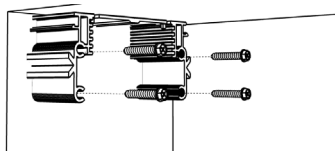

Inside Mount

*(Horizontal installation - Possible with longer installation screws)*

## Outside Mount *(Backplate Placement)*

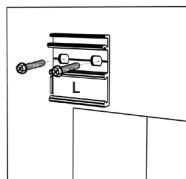

Using the drill secure the backplates to the opening - Each is marked Left or Right. Be sure to check that they are level.

## Outside Mount *(Fascia Bracket Placement)*

Slide the Fascia bracket onto the outside mount bracket. Slide all the way to the edge of the bracket until it stops.

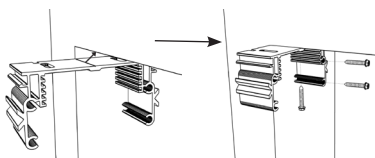

## Inside Mount Shade- Outside Mount Bracket *(Fascia Bracket Placement and installation)*

Position the top line against the front edge of the wall then secure the bracket with installation screws as shown.

STEP 2

# SHADE BRACKET INSTALLATION

Once the Fascia installation brackets are secured, insert the shade installation brackets into the slots of the Deco Fascia bracket as shown.

For outside mounted shades, the shade bracket should be inserted into the top slot. *\*Please note: The bracket should be inserted all the way into the slot in order for it to be positioned to stay in place.*

For inside mounted shades, the shade bracket can be moved up or down to perfectly level the shade as needed.

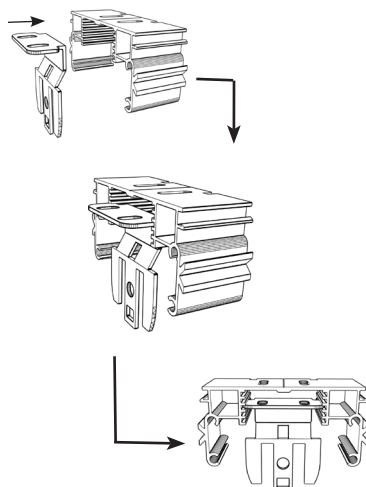

---

**STEP 3**

**SHADE PLACEMENT**

Once the brackets are secured and level, locate the Bearing Pin from the parts sent with your shade. Insert the Bearing Pin on to the left side bracket (as shown). You should hear a click once it is securely installed.

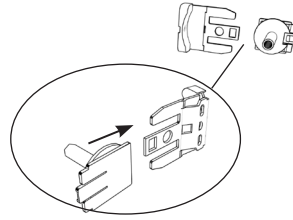

Grab the roller shade and insert the left side of the shade into the Bearing Pin (as shown)

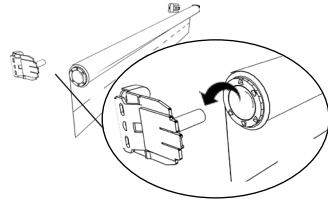

Insert the opposite end of the shade onto the bracket as shown.

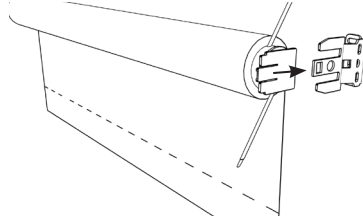

**STEP 4**

**DECO FASCIA  
INSTALLATION**

**INSIDE MOUNT**

Inside Mounted fascia can be installed by snapping the back groove onto the front notch of each installed Fascia bracket.

*You will hear a click when it is installed*

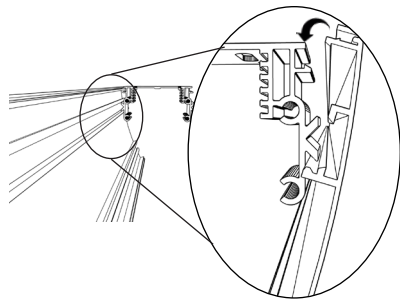

**STEP 4**

**DECO FASCIA  
INSTALLATION (CONTINUED)**

**OUTSIDE MOUNT** *(if ordered)*

Attach the return with the supplied connector.

- Metal returns will include a plastic corner connector *(outside mount only)*
- Plastic returns simply snap on the end of the fascia *(inside mount shade with outside mounted fascia)*

Install the fascia by snapping the back groove onto the front notch of each installed Fascia bracket.

*You will hear a click when it is installed*

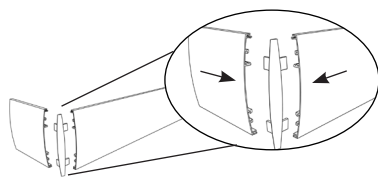

*Metal return installation*

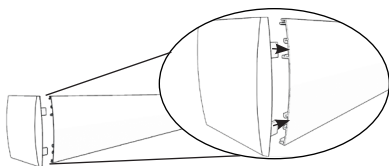

*Plastic return installation*

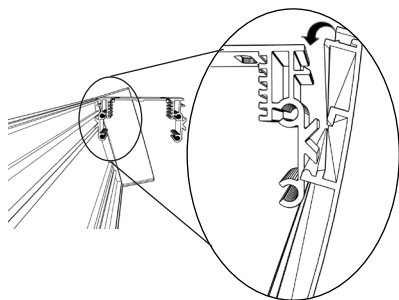

*Fascia installation*



---

STEP 5

## PROGRAMING INSTRUCTIONS

Refer to programing instructions included with your order. Online guides can be located using the QR codes below.

### HOW TO GUIDES



Remote Control Guide



Otto Recharge Motor Guide



Otto 30/DC2 Motor Guide



App Set Up Guide



Wifi Bridge Set Up Guide



Recharge Battery Pack

### VIDEOS



Pairing and Waking the Motor



Setting & Adjusting Limits



Setting the Favorite Position



Locking & Unlocking the Remote



Group Shades with P1 Button on Motor



Group Shades with P2 Button on Remote

---

## TROUBLESHOOTING

Shade is rolling up on tube unevenly or tracks:

If you notice the material winds unevenly and begins to track or telescope to one side check to ensure that the shade is level. If the shade is not level, remove it from the mounting brackets and shim or reinstall the brackets, as necessary.

**IMPORTANT NOTE:** Operating a shade that is not level will result in damage to the material. Damage caused by operating an unlevel shade is not covered under our normal warranty.

---

