

Atelier Roller Shade Chain Control Shade Installation Instructions

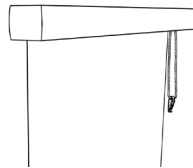
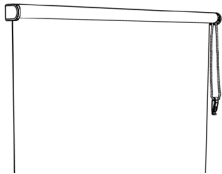
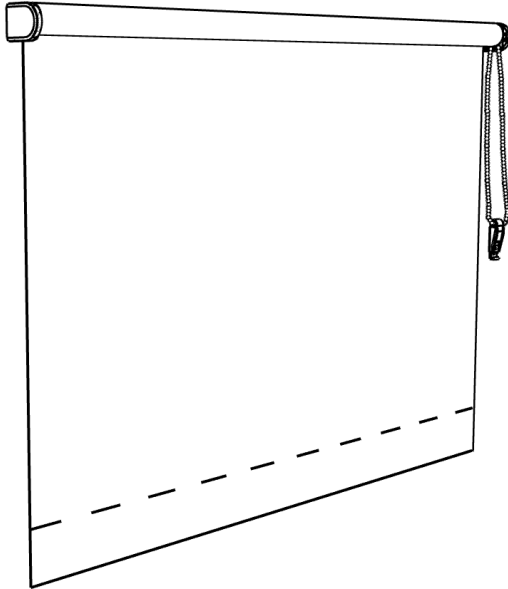

1. Chain Control Open Roll
2. Chain Control with Deco Fascia

GETTING STARTED

Make sure you have all of the parts and tools required to install your shades.

Tools:

- Measuring Tape
- Power Drill
- #2 Phillips Screwdriver or
- ¼" Hex Head

General Parts to Install Your Shade:



Installation Brackets

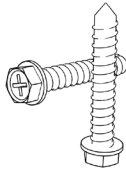

Screws

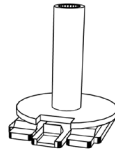

Bearing Pin

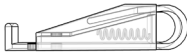

Safety Tension Device

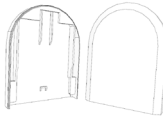

Bracket Cover
(if ordered)

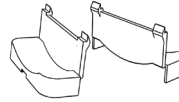

Screw Covers
(if ordered)

Deco Fascia Installation Parts (supplied if Deco Fascia was ordered):



Deco Fascia

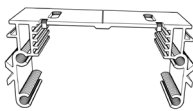

Deco Fascia
Installation Brackets



Outside Mount
Backplate
(if ordered)

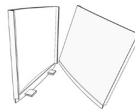

Plastic/Metal
Returns
(if ordered)

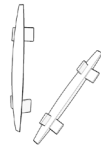

Corner Pieces
*(Outside mounted
only)*

SECTION 1

CHAIN CONTROL SHADE - OPEN ROLL

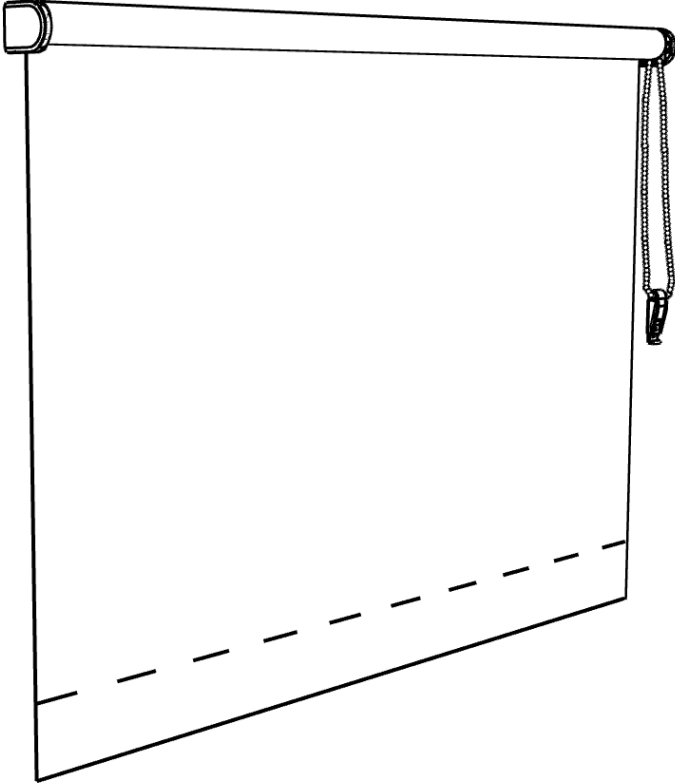

If your shades were ordered with Deco Fascia, proceed to Section 2

STEP 1

INSTALLATION BRACKET PLACEMENT

Using the Drill, secure the roller shade installation brackets with the supplied screws (as shown).

Be sure to check that they are level.

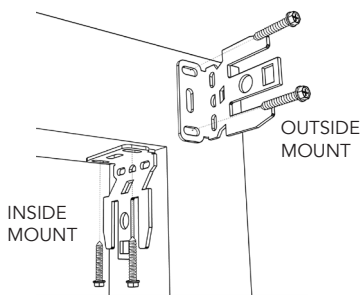

If shade was ordered as Outside Mount, attach the supplied screw covers on to the bracket for a finished look.

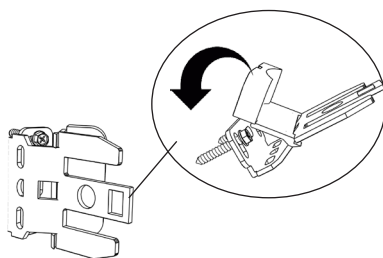

STEP 2

SHADE PLACEMENT

Once the brackets are secured and level, locate the Bearing Pin from the parts sent with your shade. Insert the Bearing Pin on to the non-chain side bracket (as shown). You should hear a click once it is securely installed.

Grab the roller shade and insert the non-chain side of the shade into the Bearing Pin (as shown)

Insert the opposite end of the shade onto the bracket as shown.

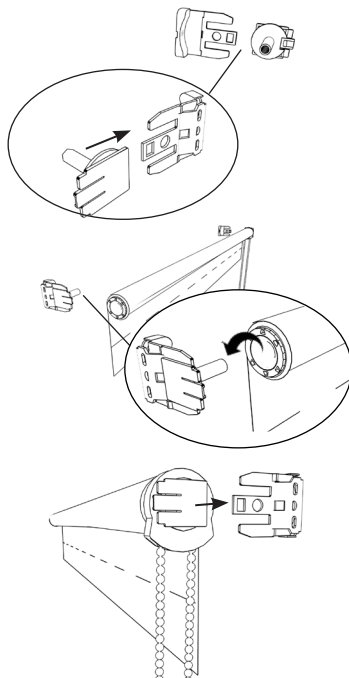

STEP 3

ADDITIONAL ITEMS

If your shade was ordered as Outside Mount, locate the bracket covers and install them onto the installation brackets as shown.

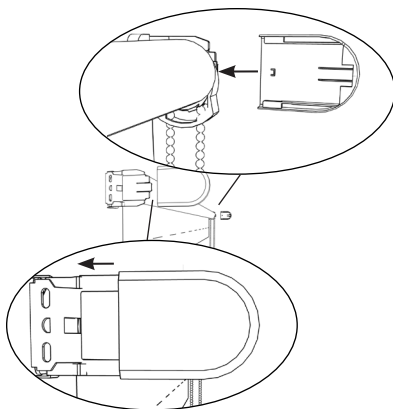

STEP 4

SAFETY TENSION DEVICE

Your roller shade was produced with an ANSI compliant safety tension device attached to the bead chain. This device must be securely mounted before the shade will operate properly.

- Slide the device to the bottom of the bead chain.
- Pull the device down until the bead chain is fully tensioned.
- Mark the screw hole location and secure in place.

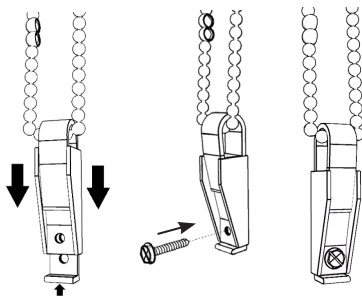

SECTION 2

CHAIN CONTROL SHADE - WITH DECO FASCIA

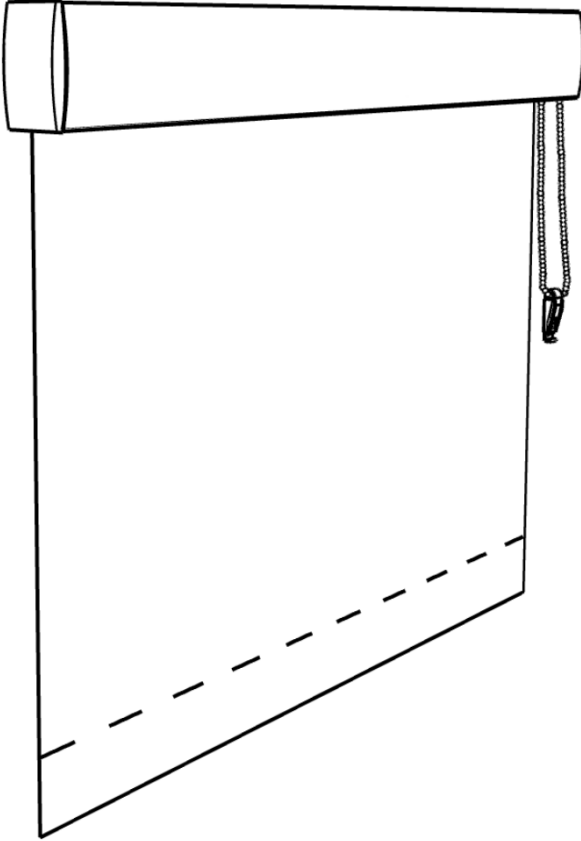

If your shades were ordered Open Roll, refer back to Section 1

STEP 1

DECO FASCIA BRACKET INSTALLATION

Using the Drill, secure the Fascia installation brackets with the supplied screws (as shown).

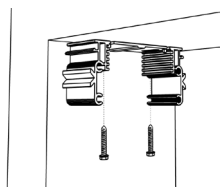

Inside Mount
(Vertical installation - Typical installation)

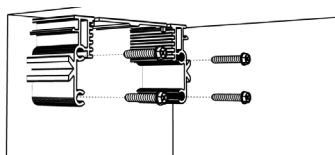

Inside Mount
(Horizontal installation - Possible with longer installation screws)

Outside Mount (Backplate Placement)

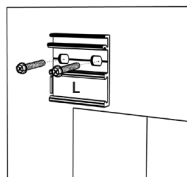

Using the drill secure the backplates to the opening - Each is marked Left or Right. Be sure to check that they are level.

Outside Mount (Fascia Bracket Placement)

Slide the Fascia bracket onto the outside mount bracket. Slide all the way to the edge of the bracket until it stops.

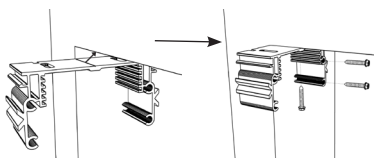

Inside Mount Shade- Outside Mount Bracket (Fascia Bracket Placement and installation)

Position the top line against the front edge of the wall then secure the bracket with installation screws as shown.

STEP 2

SHADE BRACKET INSTALLATION

Once the Fascia installation brackets are secured, insert the shade installation brackets into the slots of the Deco Fascia bracket as shown.

For outside mounted shades, the shade bracket should be inserted into the top slot. **Please note: The bracket should be inserted all the way into the slot in order for it to be positioned to stay in place.*

For inside mounted shades, the shade bracket can be moved up or down to perfectly level the shade as needed.

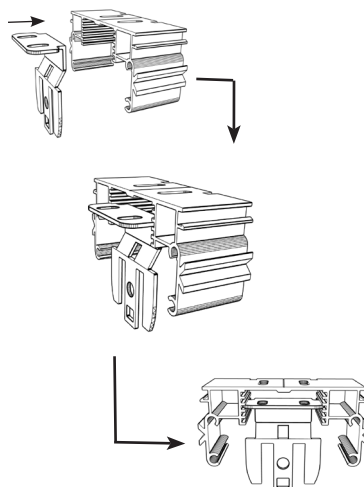

STEP 3

SHADE PLACEMENT

Once the brackets are secured and level, locate the Bearing Pin from the parts sent with your shade. Insert the Bearing Pin on to the non-chain side bracket (as shown). You should hear a click once it is securely installed.

Grab the roller shade and insert the non-chain side of the shade into the Bearing Pin (as shown)

Insert the opposite end of the shade onto the bracket as shown.

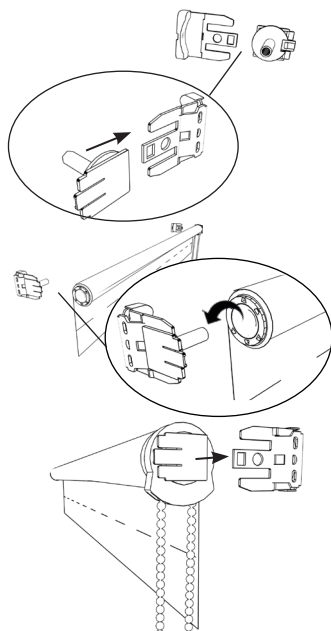

STEP 4

SAFETY TENSION DEVICE

Your roller shade was produced with an ANSI compliant safety tension device attached to the bead chain. This device must be securely mounted before the shade will operate properly.

- Slide the device to the bottom of the bead chain.
- Pull the device down until the bead chain is fully tensioned.
- Mark the screw hole location and secure in place.

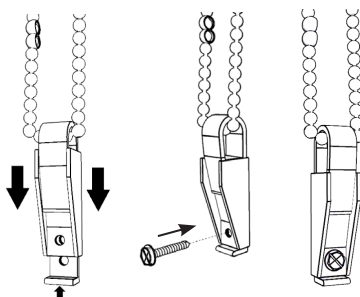
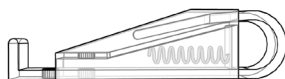

STEP 5

**DECO FASCIA
INSTALLATION**

INSIDE MOUNT

Inside Mounted fascia can be installed by snapping the back groove onto the front notch of each installed Fascia bracket.

You will hear a click when it is installed

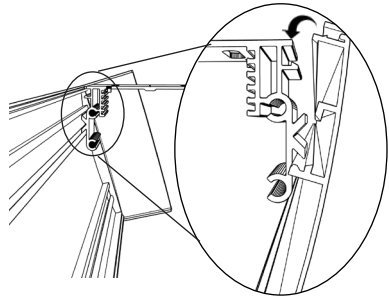

OUTSIDE MOUNT (if ordered)

Attach the return with the supplied connector.

- Metal returns will include a plastic corner connector (outside mount only)
- Plastic returns simply snap on the end of the fascia (inside mount shade with outside mounted fascia)

Install the fascia by snapping the back groove onto the front notch of each installed Fascia bracket.

You will hear a click when it is installed

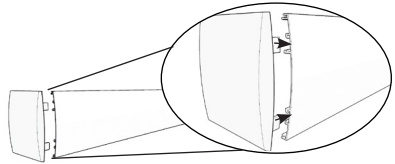

Plastic return installation

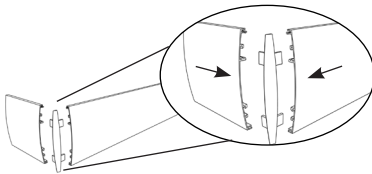

Metal return installation

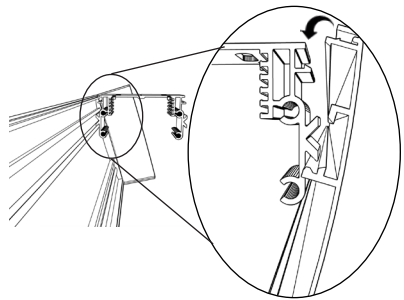

Fascia installation

TROUBLESHOOTING

Shade is rolling up on tube unevenly or tracks:

If you notice the material winds unevenly and begins to track or telescope to one side check to ensure that the shade is level. If the shade is not level, remove it from the mounting brackets and shim or reinstall the brackets, as necessary.

IMPORTANT NOTE: Operating a shade that is not level will result in damage to the material. Damage caused by operating an unlevel shade is not covered under our normal warranty.

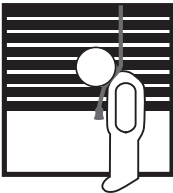
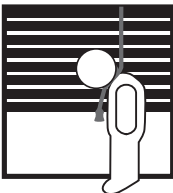
⚠ WARNING	
	Window Blind Cord Can STRANGLE Your Child To prevent strangulation, purchase cordless products or products with inaccessible cords
⚠ ADVERTENCIA	
	La cuerda ciega de la ventana puede ESTRANGULAR su niño Para evitar el estrangulamiento, compre alternativas inalámbricas o productos con cables inaccesibles
